



## TUTORIAL



TITLE

### TWO-BREASTED WOOL JACKET

FROM THE FEATURE

Spring Fashion - from 10 to 20°C

SISTERMAG

N°18

SIZE 36/38

### MATERIALS

- » 1,2m velour for coats
- » 1,2m lining
- » 8 buttons
- » interlining

### HOW-TO

1. Sew the darts on the sleeves and back panel
2. Sew in the arm gussets according to the numbers on the pattern, close the lower sleeve and side seams
3. Sew the flap pockets
4. Strengthen the collar with interlining, turn it over and iron it
5. Place the trimming right side on right side
6. Sew the upper edge up to the symbol
7. Attach the collar sewing in the trimming between collar and shirt
8. Turn over the trimming and iron
9. Sew the lower edge of the jacket
10. Turn over the hem of the sleeves and iron
11. Sew the lining and outer jacket
12. Sew the lining into the jacket
13. Sew the button holes
14. Attach the buttons



## PATTERN - OVERVIEW

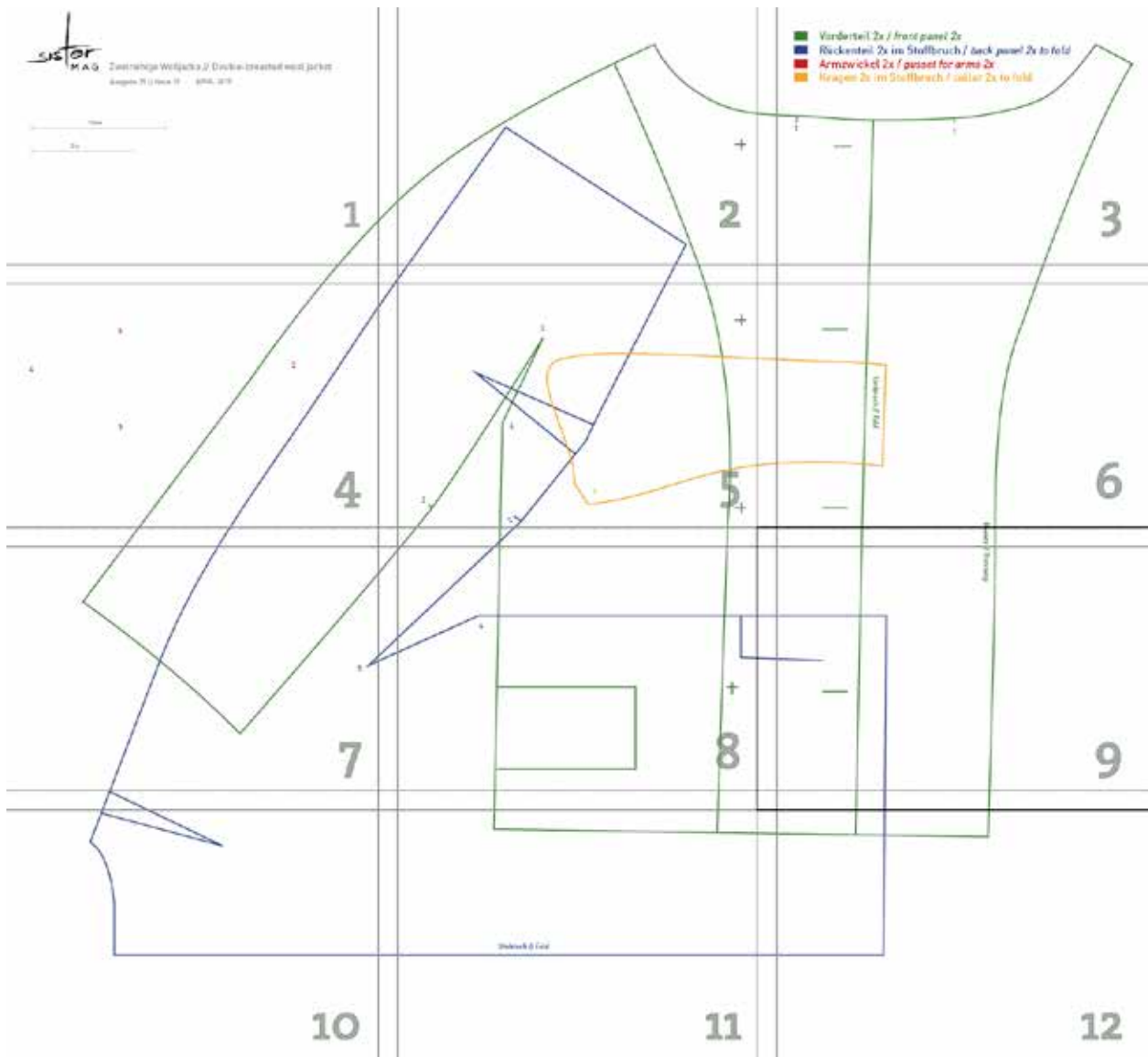

- front panel (2x)
- back panel (1x to fold)
- gusset for arms (2x)
- collar (2x to fold)

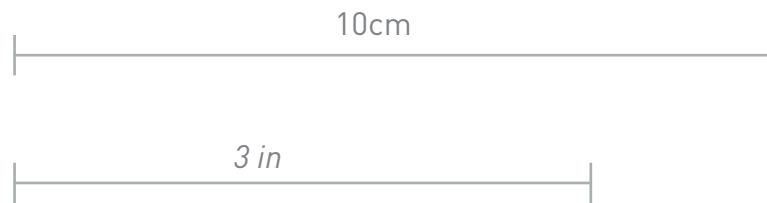

1

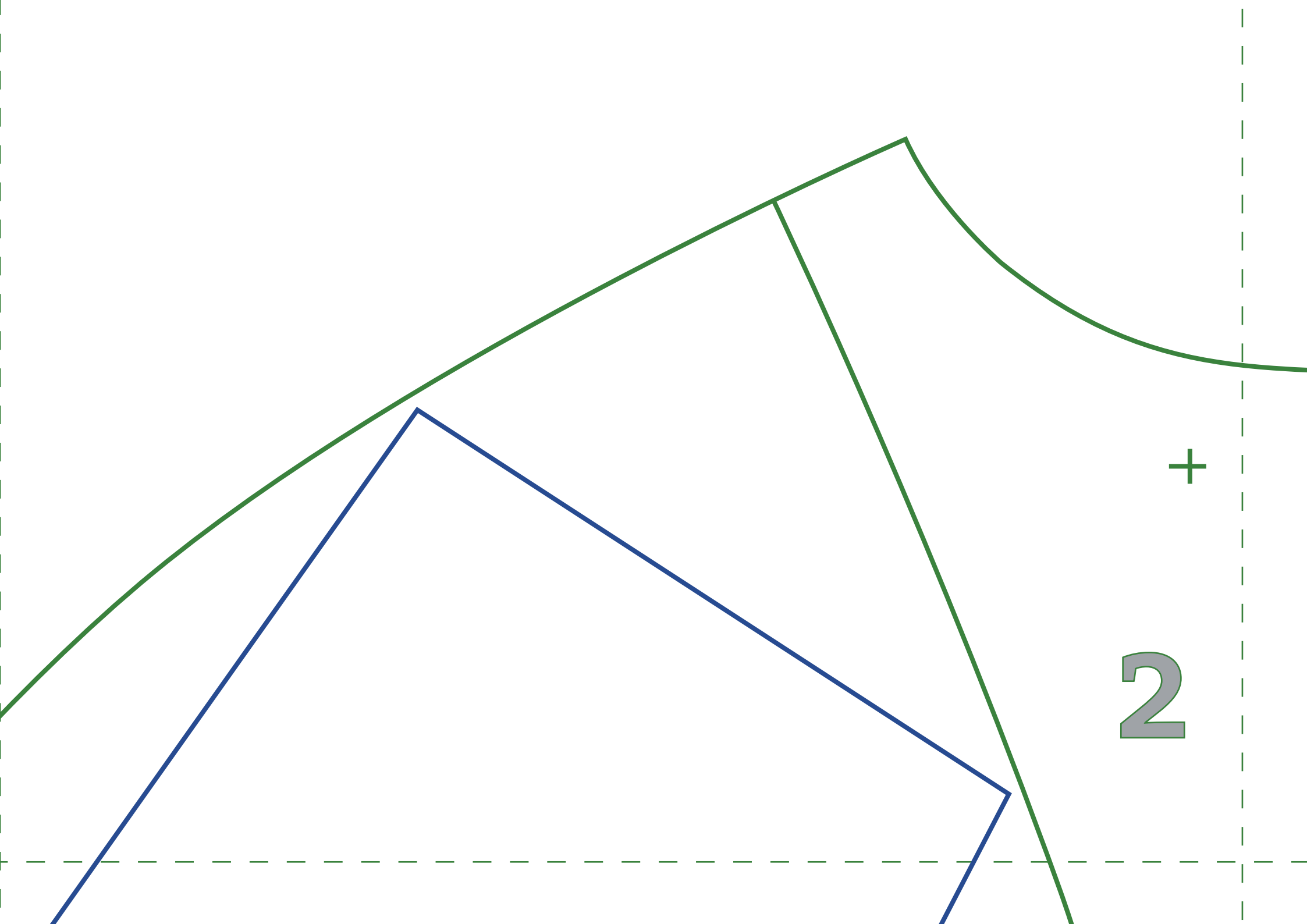

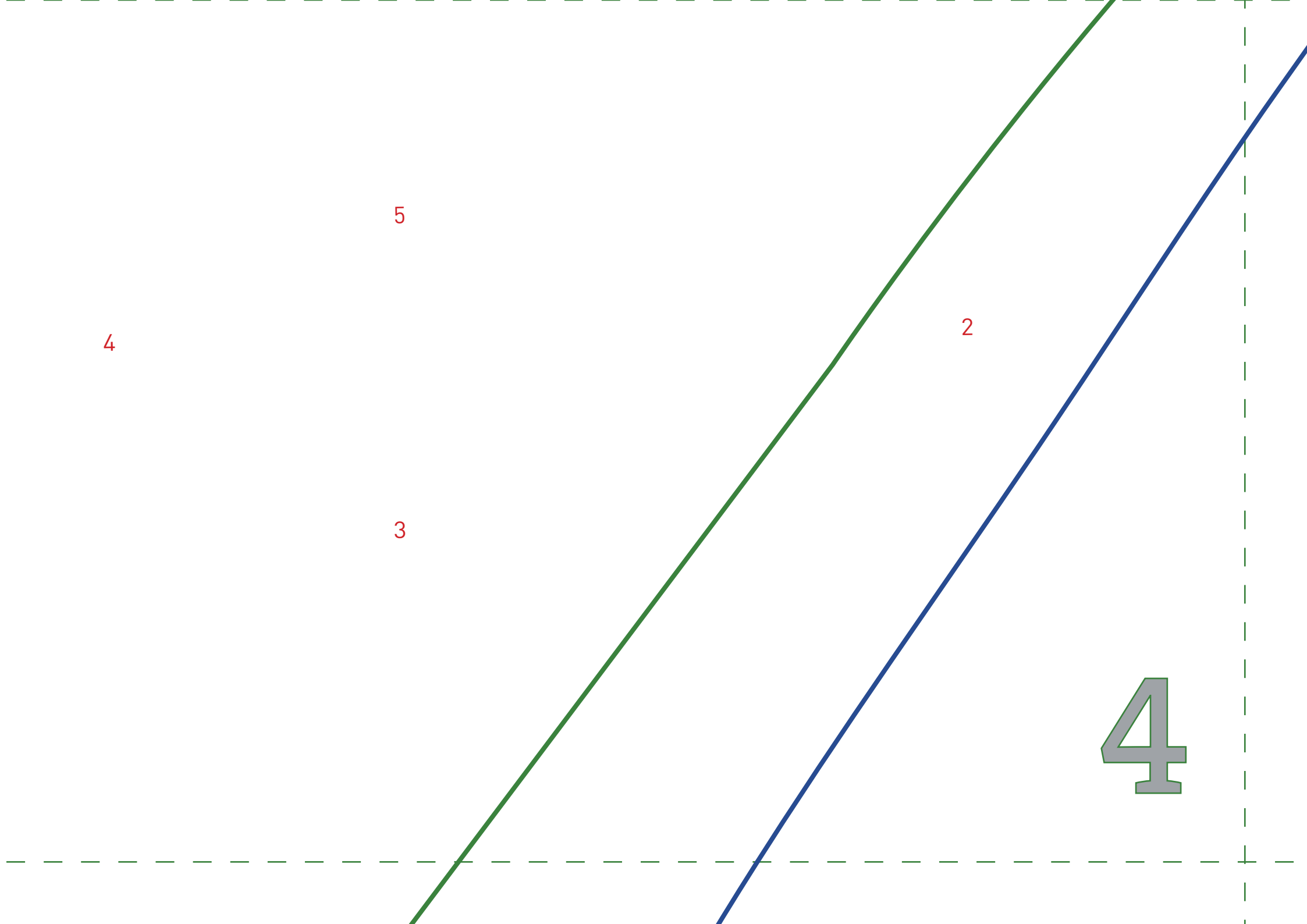

4

5

3

2

4

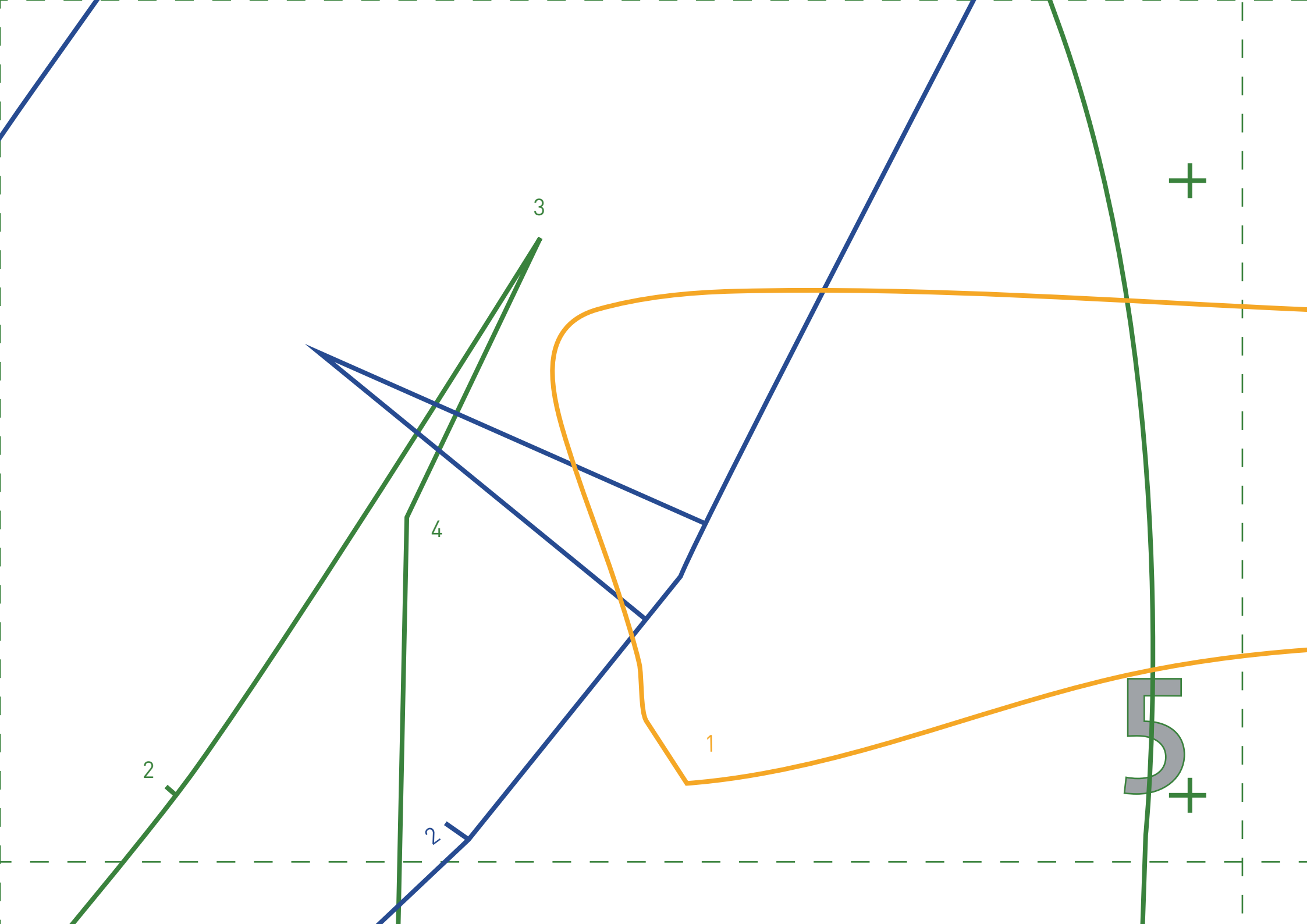

+

3

4

2

2

1

5

+

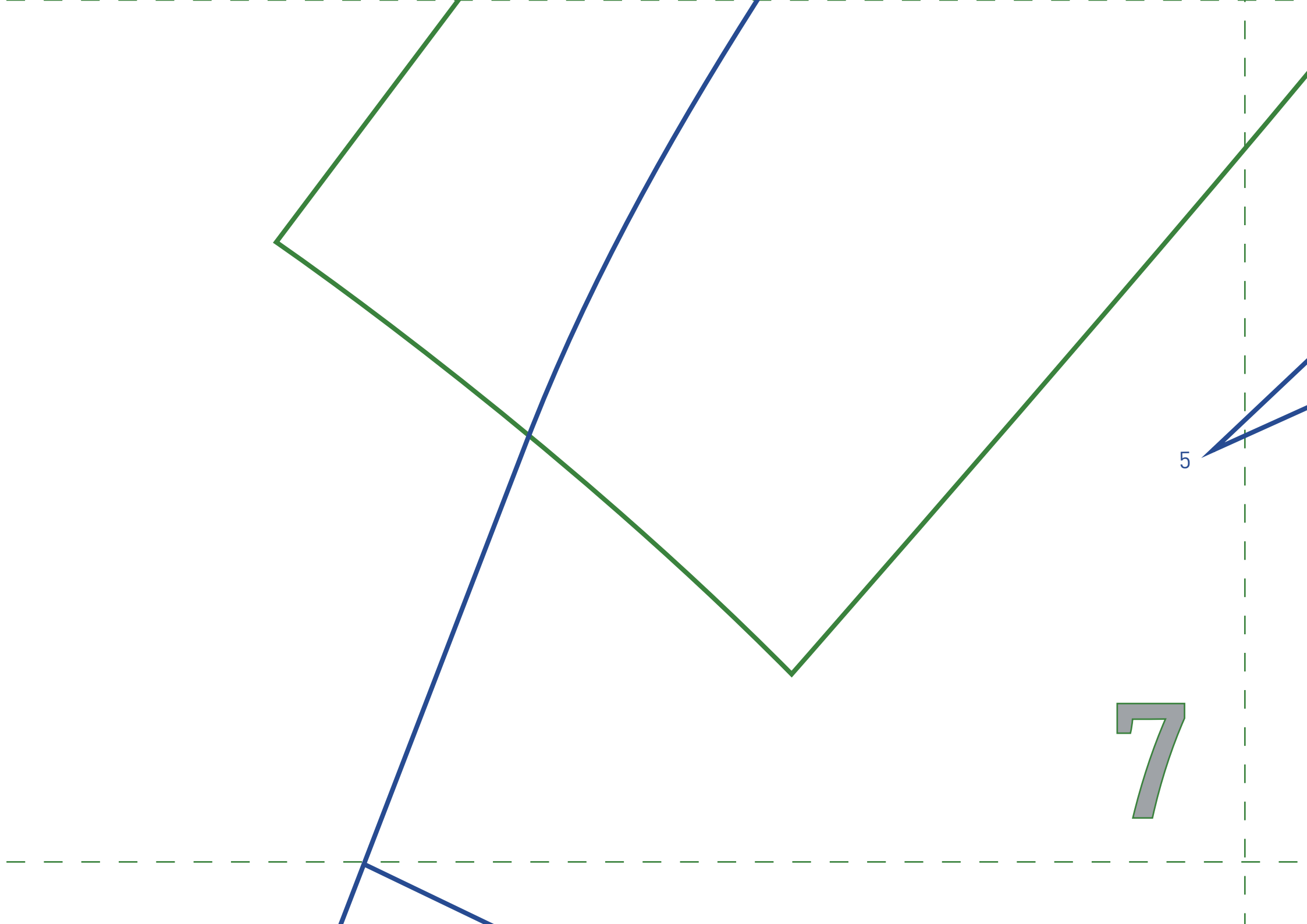

5

7

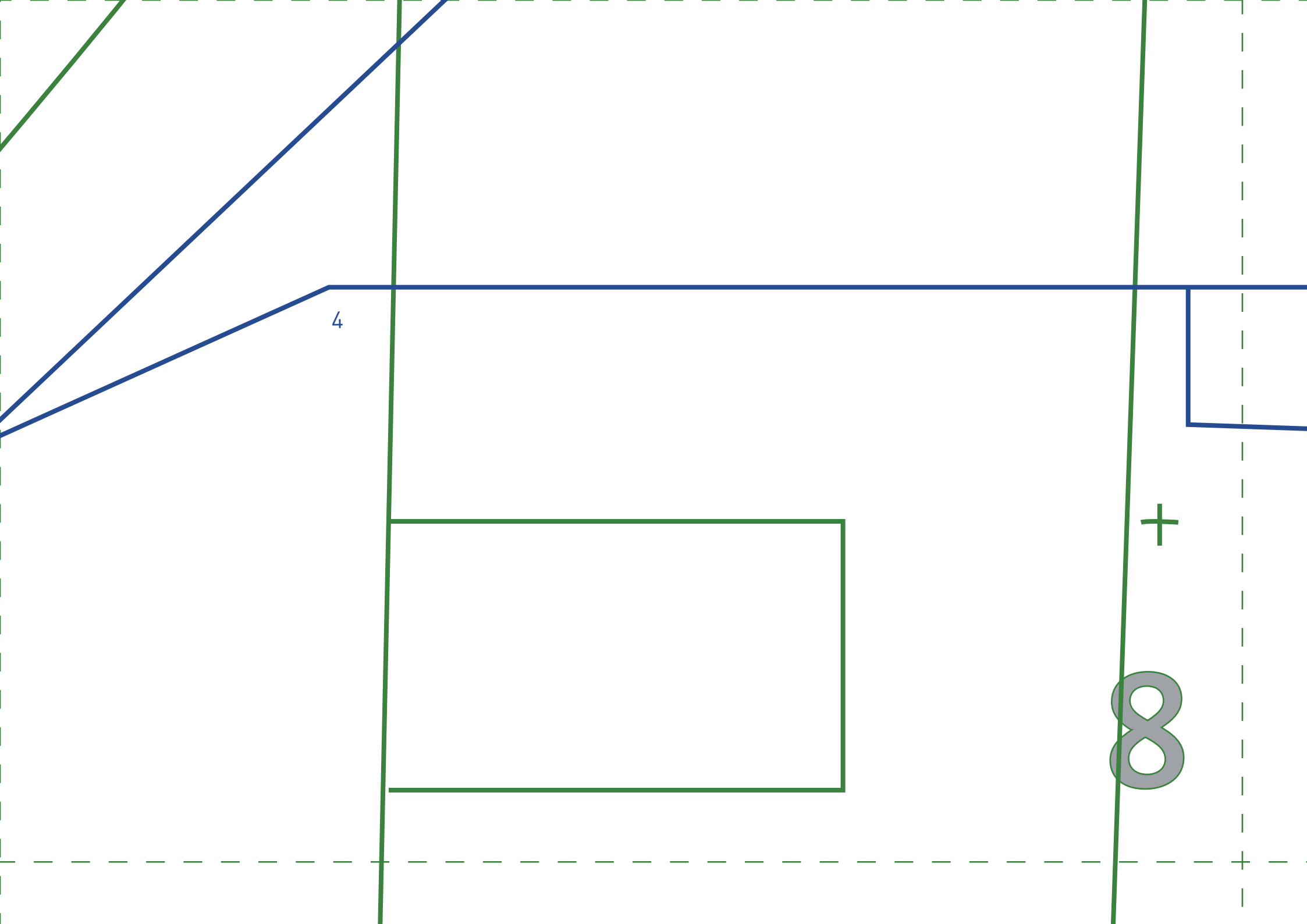

4

8

+



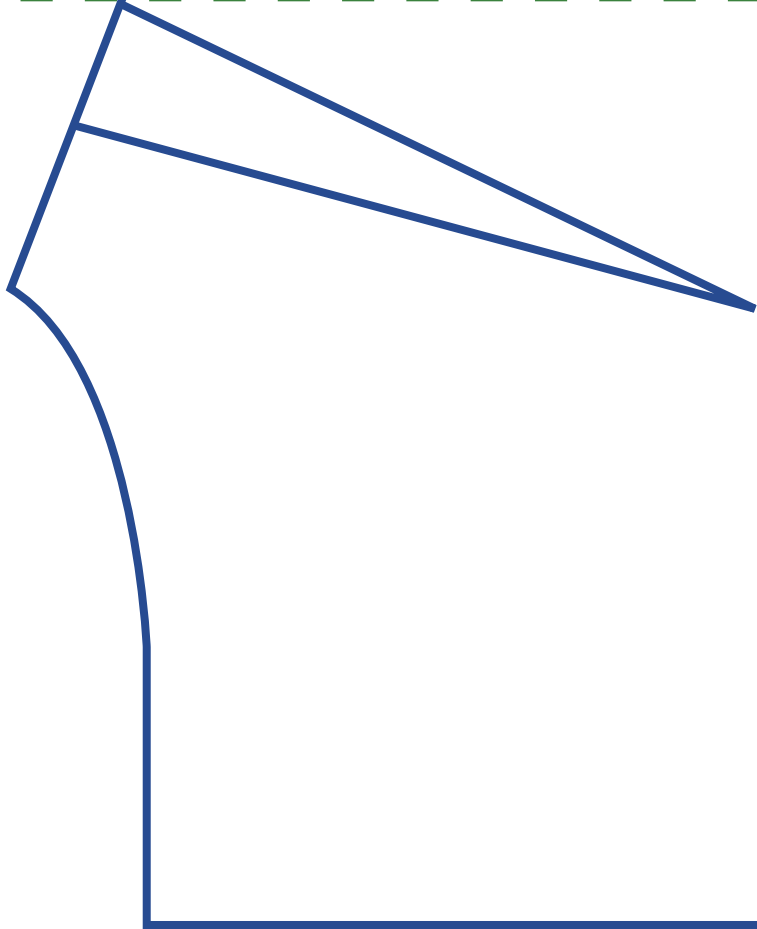

10



Umbruch // *Fold*

11

- Vorderteil 2x / *front panel 2x*
- Rückenteil 2x im Stoffbruch / *back panel 2x to fold*
- Armzwickel 2x / *gusset for arms 2x*
- Kragen 2x im Stoffbruch / *collar 2x to fold*

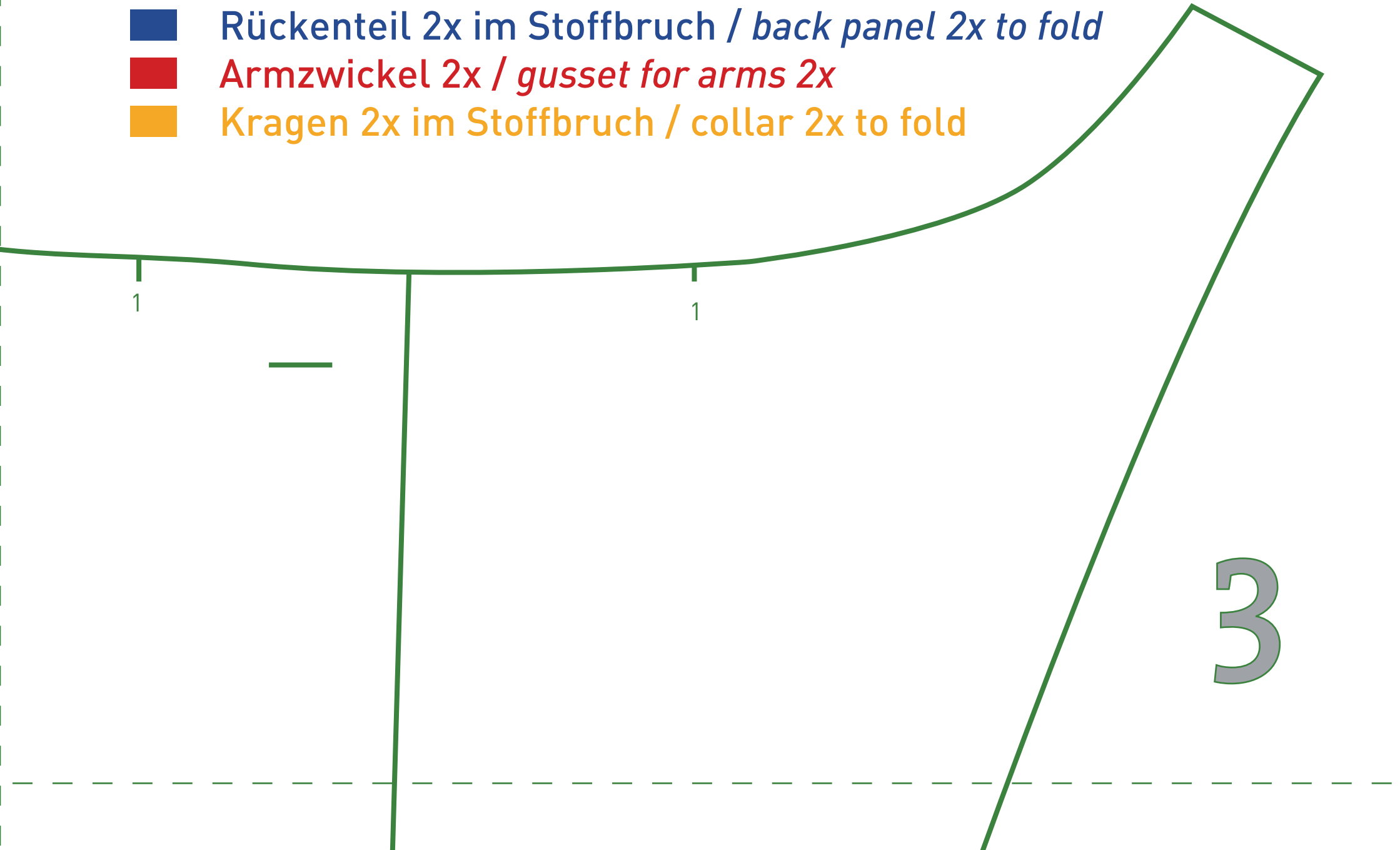

9

Besatz /

Umbruch // Fold



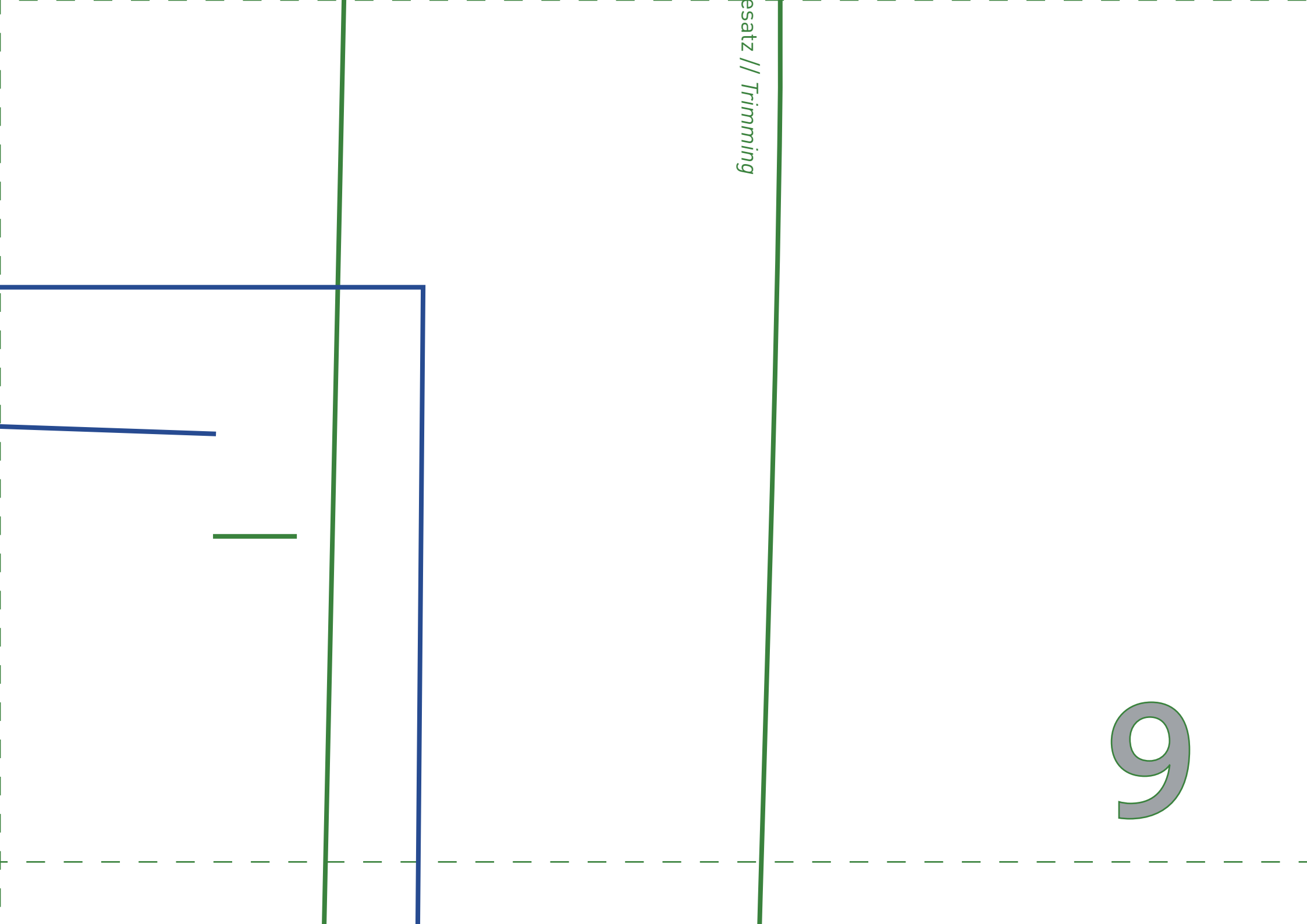

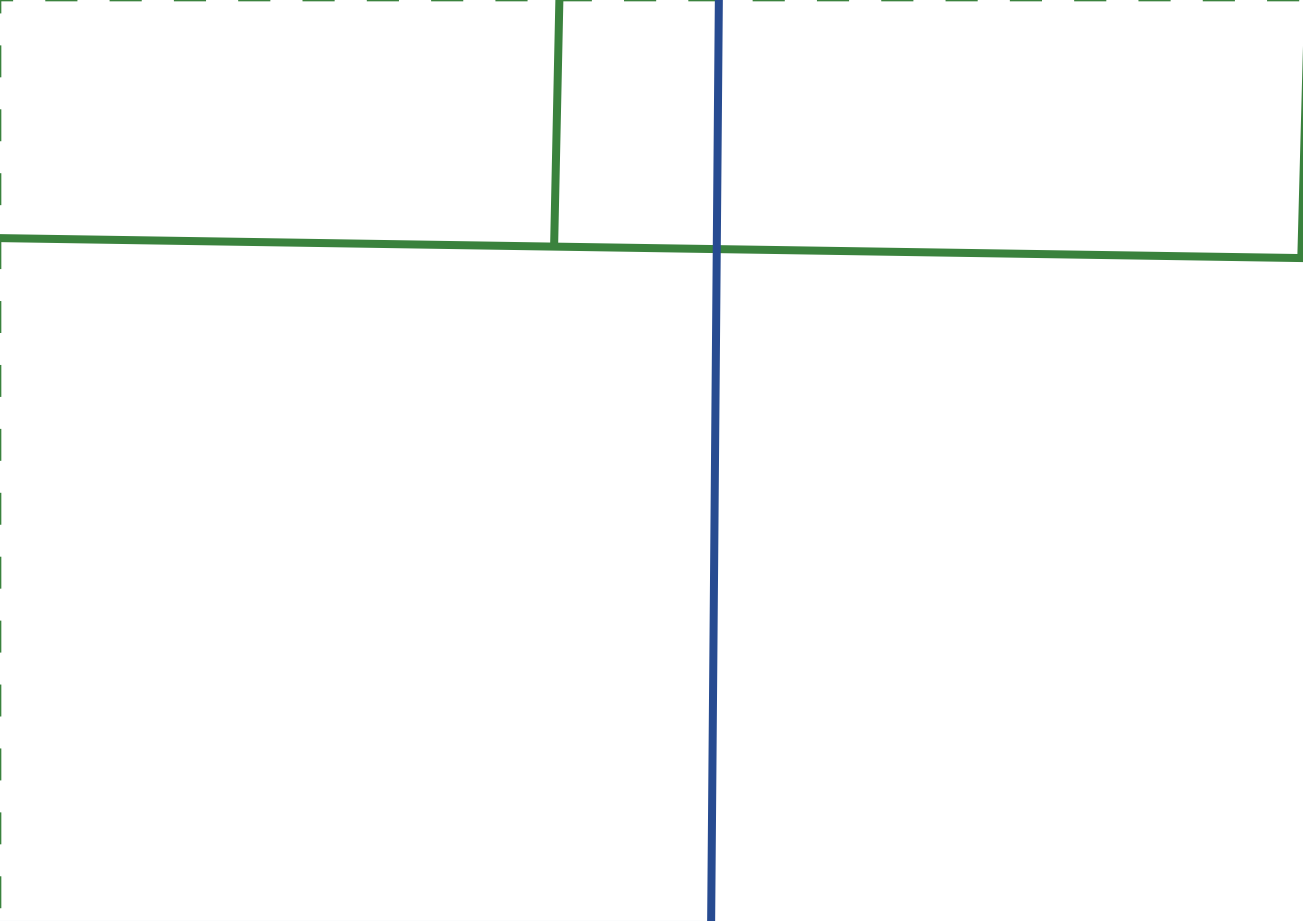

12